

11. Quantum Hall Effect / Fermi Surfaces

Nov. 8, 2018

Quantum Hall Effect

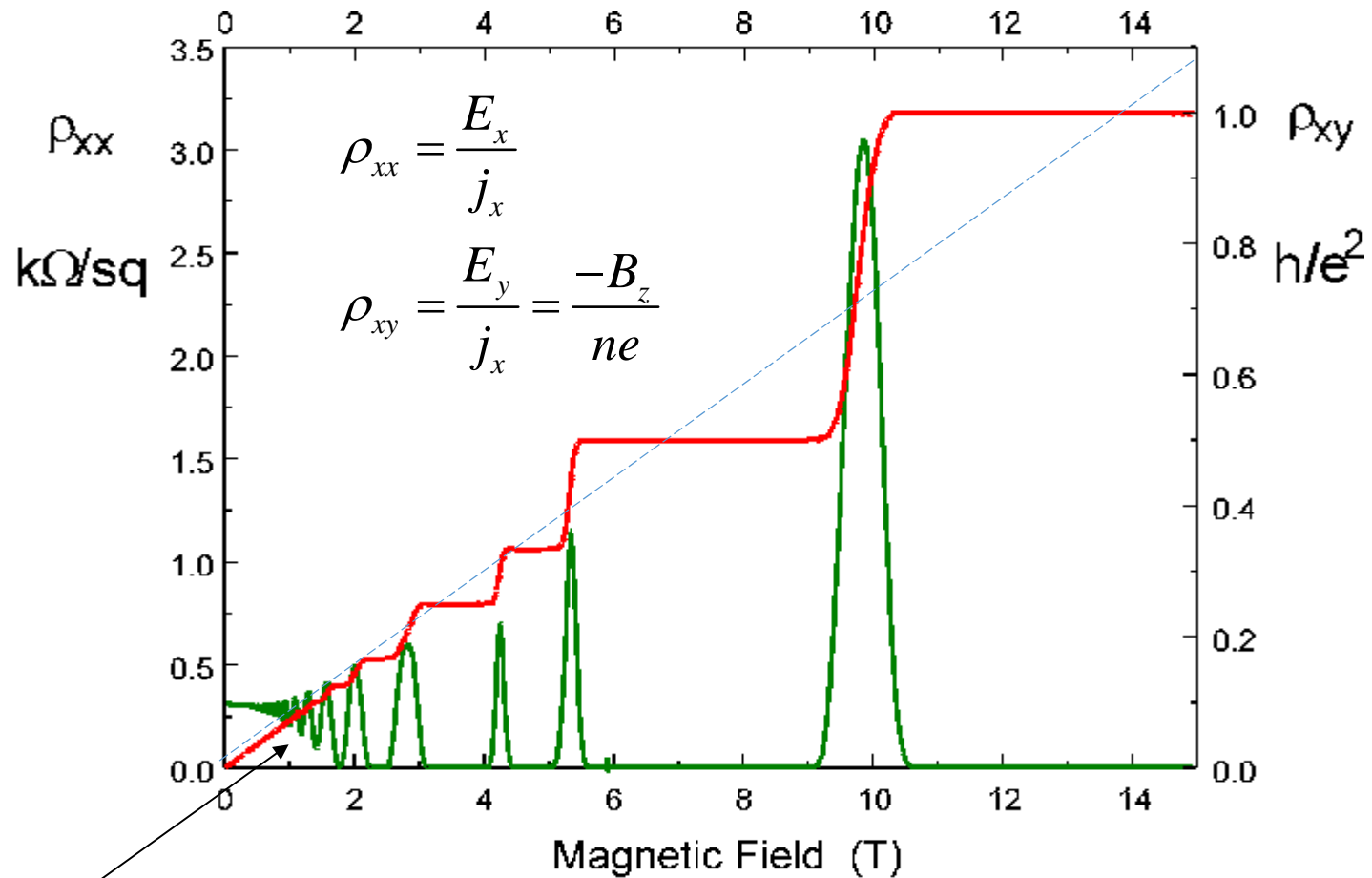

Shubnikov-De Haas oscillations

Resistance standard
25812.807557(18) Ω

Quantum Hall effect

Edge states are responsible for the zero resistance in ρ_{xx}

On the plateaus, resistance goes to zero because there are no states to scatter into.

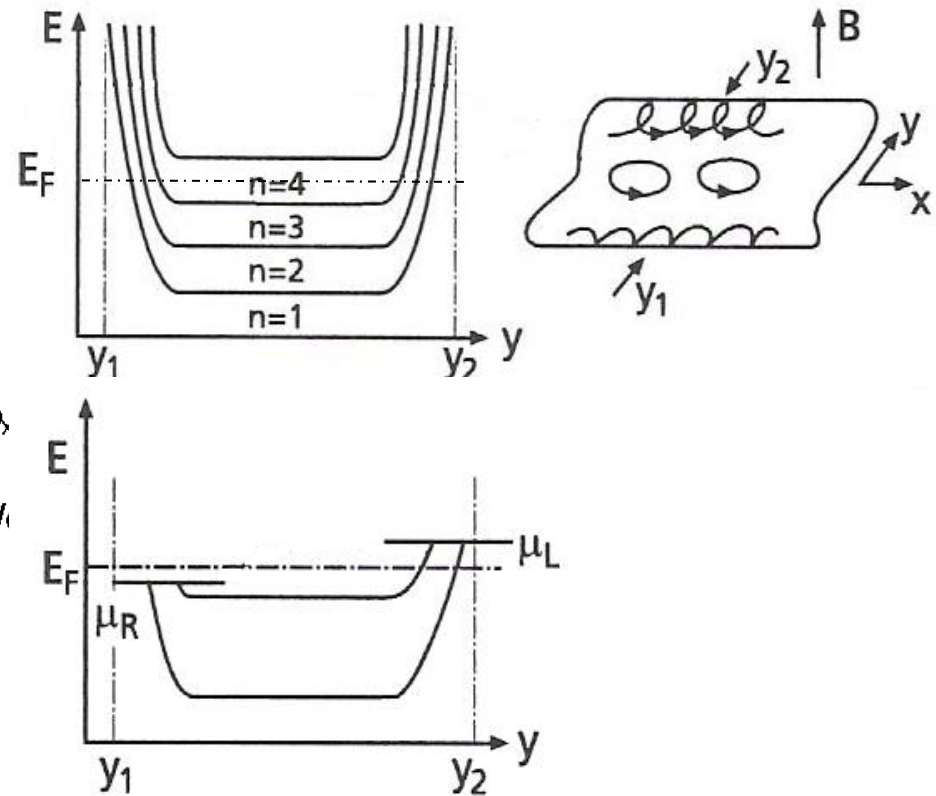
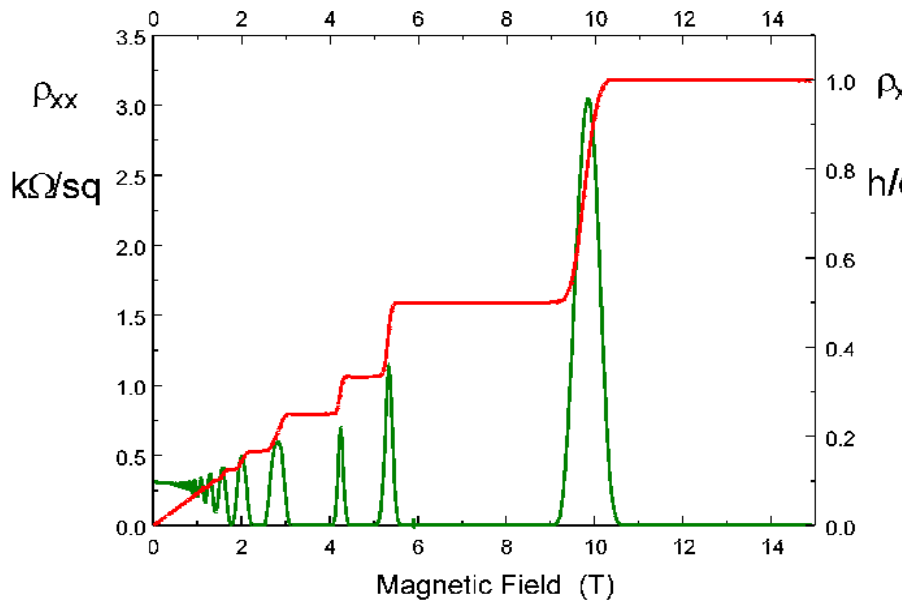

Ibach & Lueth (modified)

Fermi sphere in a magnetic field

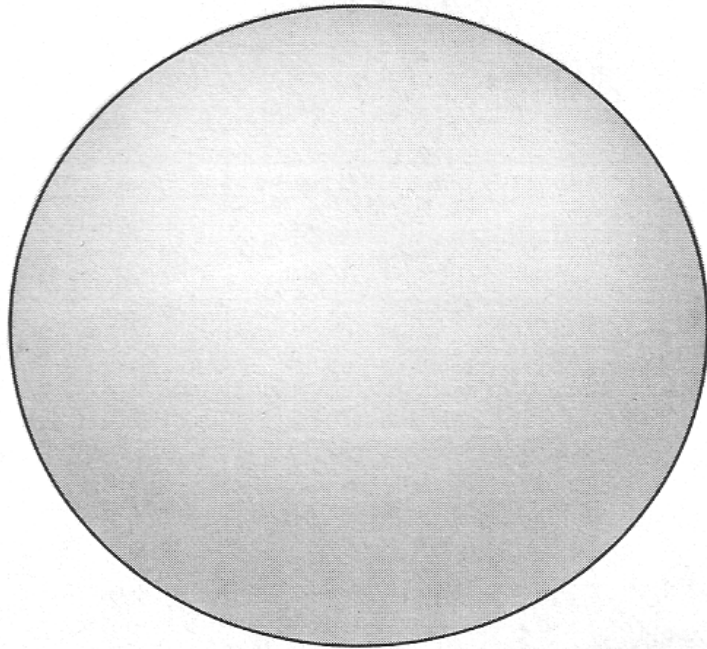

$B = 0$

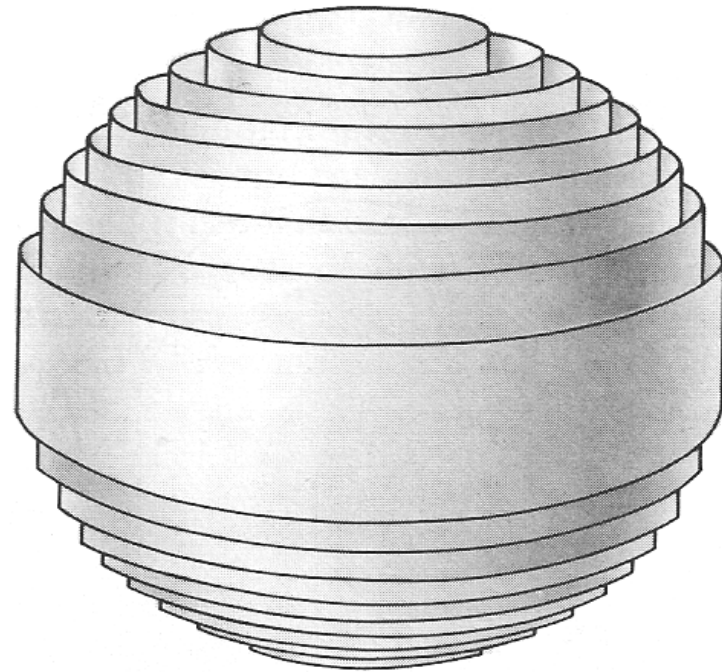

$B \neq 0$

Landau cylinders

Density of states 3d

convolution of

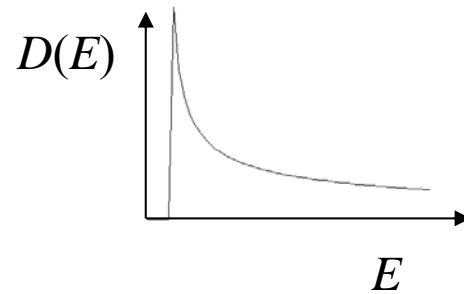

and

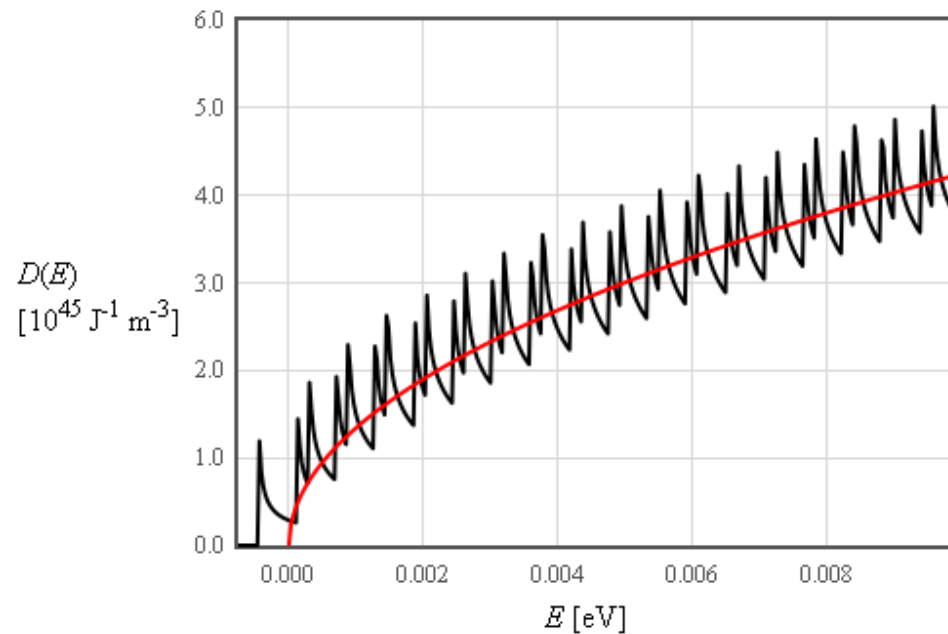
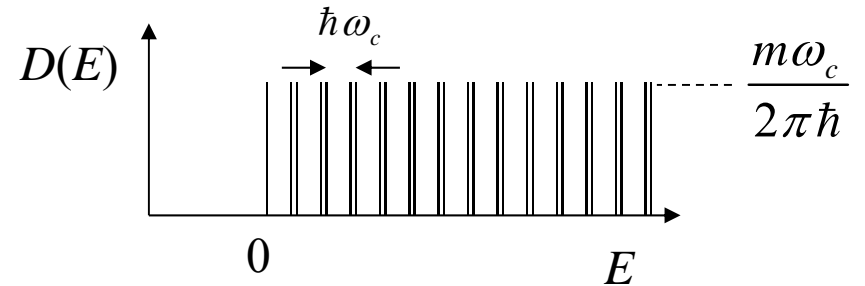

$$D(E) = \frac{(2m)^{3/2} \omega_c}{8\pi^2 \hbar^2} \left(\sum_{\nu=0}^{\infty} \frac{H(E - \hbar\omega_c (\nu + \frac{1}{2} - g/4))}{\sqrt{E - \hbar\omega_c (\nu + \frac{1}{2} - g/4)}} + \frac{H(E - \hbar\omega_c (\nu + \frac{1}{2} + g/4))}{\sqrt{E - \hbar\omega_c (\nu + \frac{1}{2} + g/4)}} \right) \text{ J}^{-1} \text{ m}^{-3}$$

Equation for free electrons in a magnetic field in 2 and 3 dimensions.

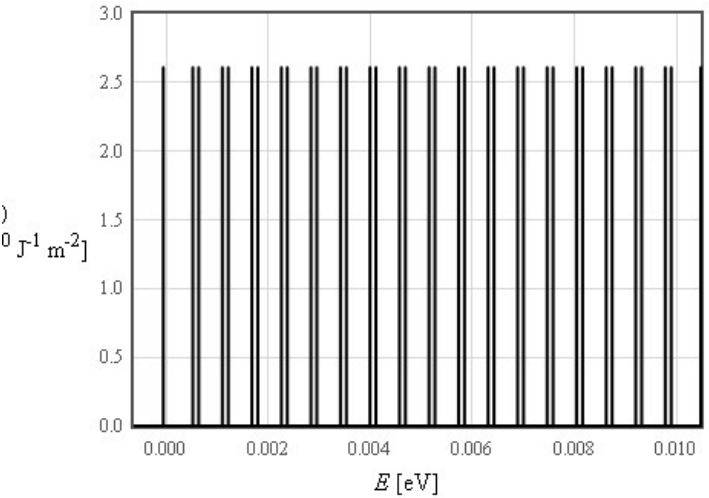
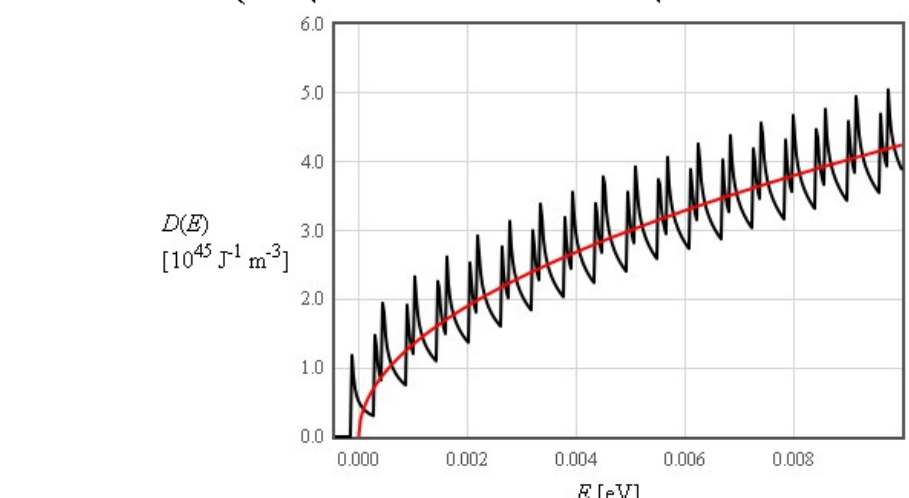
<p>2-D Schrödinger equation</p> $i\hbar \frac{d\psi}{dt} = \frac{1}{2m} (-i\hbar \nabla - e \vec{A})^2 \psi$	<p>3-D Schrödinger equation</p> $i\hbar \frac{d\psi}{dt} = \frac{1}{2m} (-i\hbar \nabla - e \vec{A})^2 \psi$
<p>$\psi = g_v(x) \exp(ik_y y)$</p> <p>$g_v(x)$ is a harmonic oscillator wavefunction</p>	<p>$\psi = g_v(x) \exp(ik_y y) \exp(ik_z z)$</p> <p>$g_v(x)$ is a harmonic oscillator wavefunction</p>
<p>$E = \hbar \omega_c (v + \frac{1}{2}) \quad \text{J}$</p> <p>$v = 0, 1, 2, \dots \quad \omega_c = \frac{ eB_z }{m}$</p>	<p>$E = \frac{\hbar^2 k_z^2}{2m} + \hbar \omega_c (v + \frac{1}{2}) \quad \text{J}$</p> <p>$v = 0, 1, 2, \dots \quad \omega_c = \frac{ eB_z }{m}$</p>
<p>$\sum_{v=0}^{\infty} \delta \left(E - \hbar \omega_c (v + \frac{1}{2}) - \frac{g\mu_B}{2} B \right) + \delta \left(E - \hbar \omega_c (v + \frac{1}{2}) + \frac{g\mu_B}{2} B \right) \quad \text{J}^{-1} \text{m}^{-2}$</p>  <p style="text-align: center;">Calculate DoS</p>	<p>$D(E) = \frac{(2m)^{3/2} \omega_c}{8\pi^2 \hbar^2} \left(\sum_{v=0}^{\infty} \frac{H(E - \hbar \omega_c (v + \frac{1}{2} - g/4))}{\sqrt{E - \hbar \omega_c (v + \frac{1}{2} - g/4)}} + \frac{H(E - \hbar \omega_c (v + \frac{1}{2} + g/4))}{\sqrt{E - \hbar \omega_c (v + \frac{1}{2} + g/4)}} \right) \quad \text{J}^{-1} \text{m}^{-3}$</p>  <p style="text-align: center;">Calculate DoS</p>

$$E_n = \hbar \omega \left(\text{Int} \left(\frac{\pi \hbar n}{\dots} \right) + \frac{1}{2} \right)$$

Energy spectral density 3d

At $T = 0$

$$u(E) = ED(E)f(E)$$

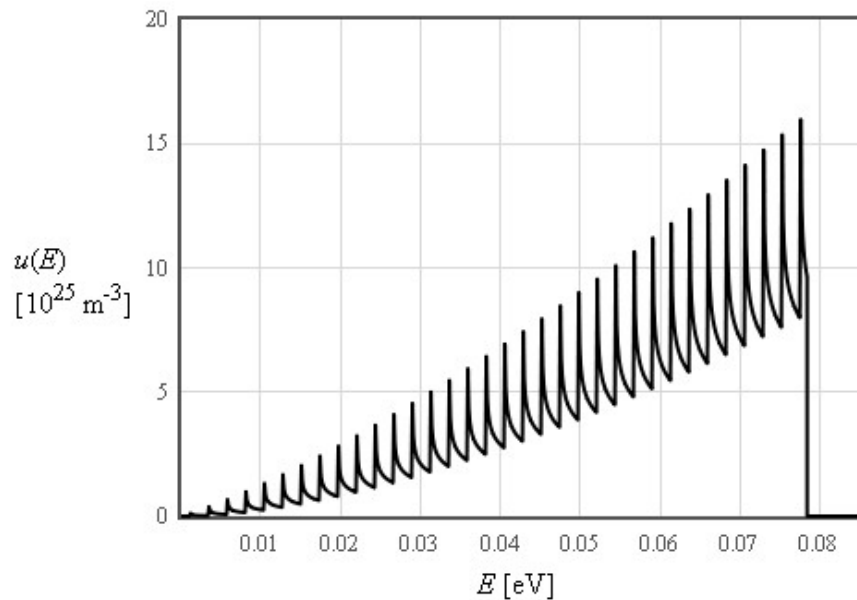

$$u(T = 0) = \int_{-\infty}^{E_F} ED(E)dE$$

Fermi energy 3d

$$n = \int_{-\infty}^{E_F} D(E)dE$$

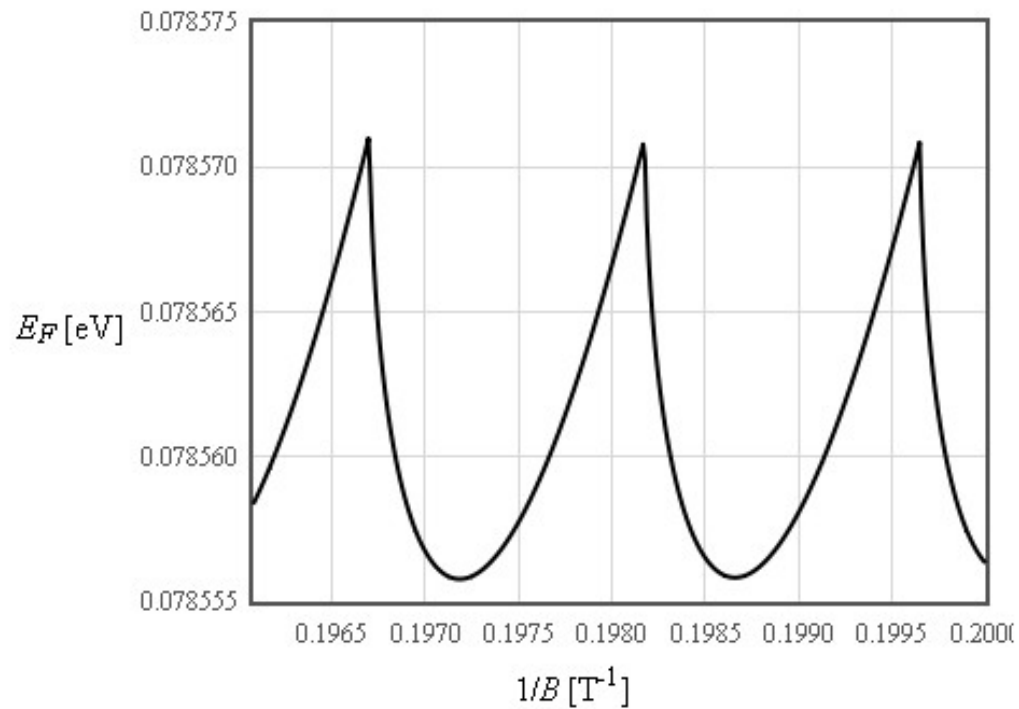

Periodic in $1/B$

Internal energy 3d

$$u = \int_{-\infty}^{E_F} E D(E) dE$$

At $T = 0$

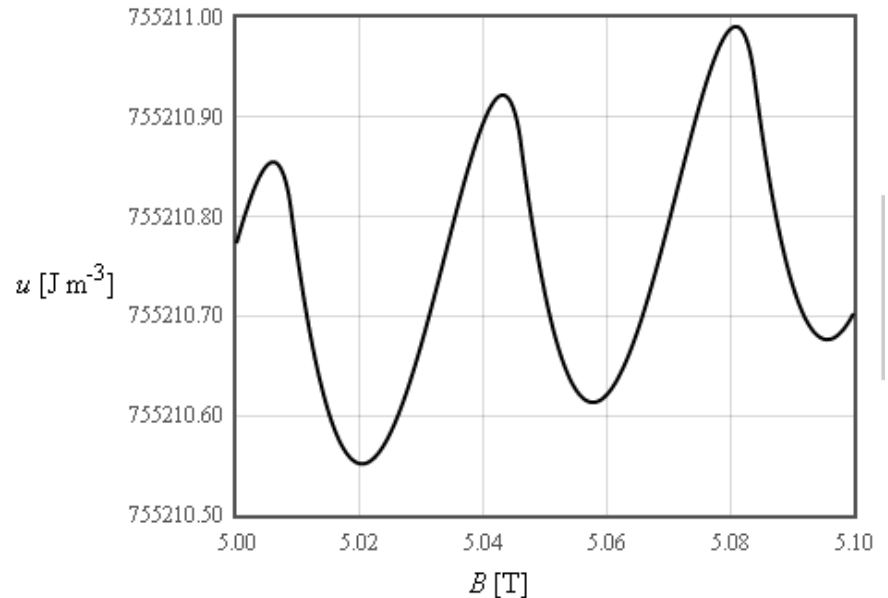

$$u = \frac{(2m)^{3/2} \omega_c}{4\pi^2 \hbar^2} \sum_{v=0}^{v < \frac{E_F}{\hbar\omega_c} - \frac{1}{2}} \int_{\hbar\omega_c(v+\frac{1}{2})}^{E_F} \frac{E dE}{\sqrt{E - \hbar\omega_c(v+\frac{1}{2})}} \quad \text{J m}^{-3}$$

$$u = \frac{(2m)^{3/2} \omega_c}{6\pi^2 \hbar^2} \sum_{v=0}^{v < \frac{E_F}{\hbar\omega_c} - \frac{1}{2}} (2\hbar\omega_c(v+\frac{1}{2}) + E_F) \sqrt{E_F - \hbar\omega_c(v+\frac{1}{2})} \quad \text{J m}^{-3}$$

Magnetization 3d

$$m = -\frac{du}{dB}$$

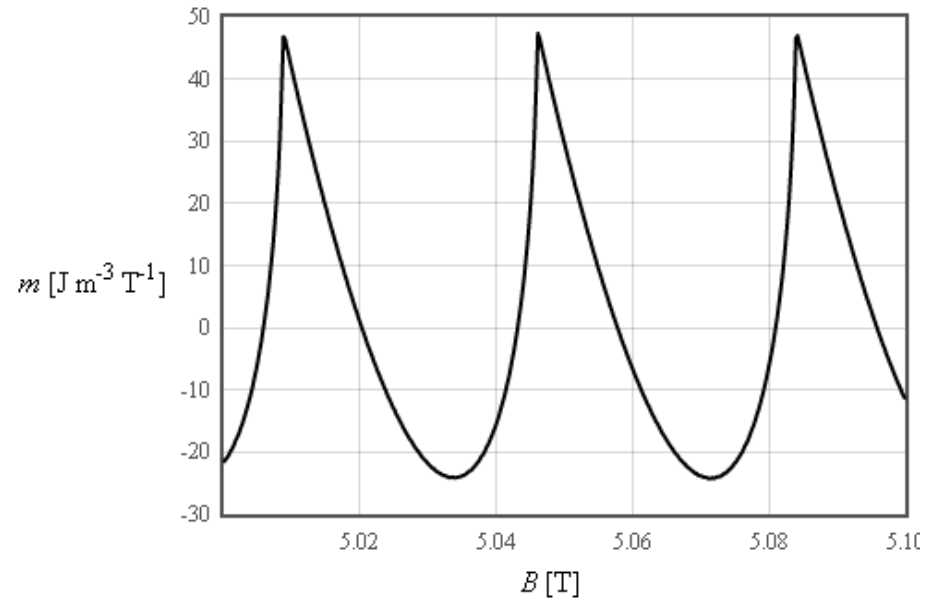

Periodic in $1/B$

At finite temperatures this function would be smoother

de Haas - van Alphen oscillations

Practically all properties are periodic in $1/B$

Internal energy

$$u = \int_{-\infty}^{\infty} ED(E)f(E)dE$$

Specific heat

$$c_v = \left(\frac{\partial u}{\partial T} \right)_{V=const}$$

Entropy

$$s = \int \frac{c_v}{T} dT$$

Helmholtz free energy

$$f = u - Ts$$

Pressure

$$P = - \left(\frac{\partial F}{\partial V} \right)_{T=const}$$

Bulk modulus

$$B = -V \frac{\partial P}{\partial V}$$

Magnetization

$$M = - \frac{dU}{dH}$$

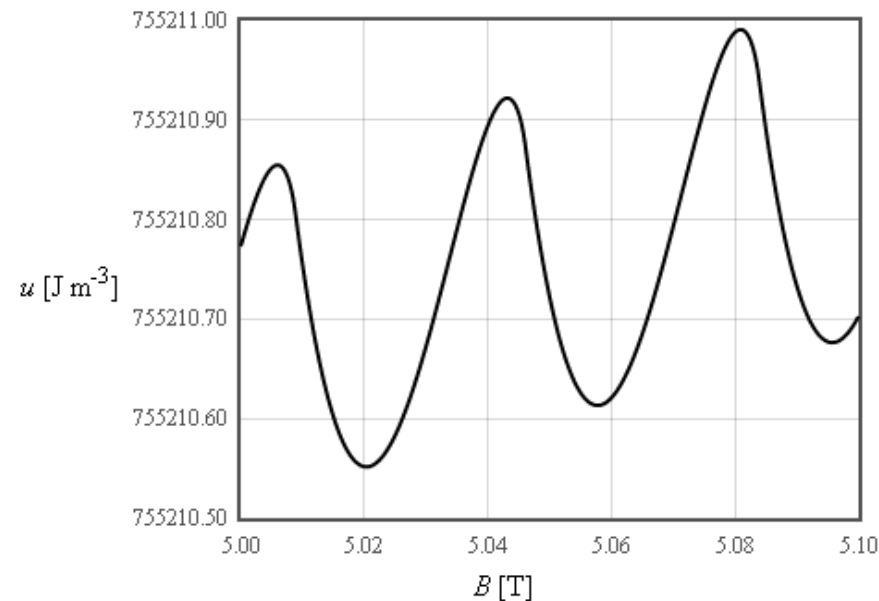

Fermi sphere in a magnetic field

Cross sectional area $S = \pi k_F^2$

$$\hbar \omega_c \left(\nu + \frac{1}{2} \right) = \frac{\hbar^2 k_F^2}{2m}$$

$$\hbar \frac{eB_\nu}{m} \left(\nu + \frac{1}{2} \right) = \frac{\hbar^2 k_F^2}{2m}$$

$$\frac{2\pi e}{\hbar} \left(\nu + 1 + \frac{1}{2} \right) = \frac{S}{B_{\nu+1}} \qquad \frac{2\pi e}{\hbar} \left(\nu + \frac{1}{2} \right) = \frac{S}{B_\nu}$$

Subtract right from left

$$S \left(\frac{1}{B_{\nu+1}} - \frac{1}{B_\nu} \right) = \frac{2\pi e}{\hbar}$$

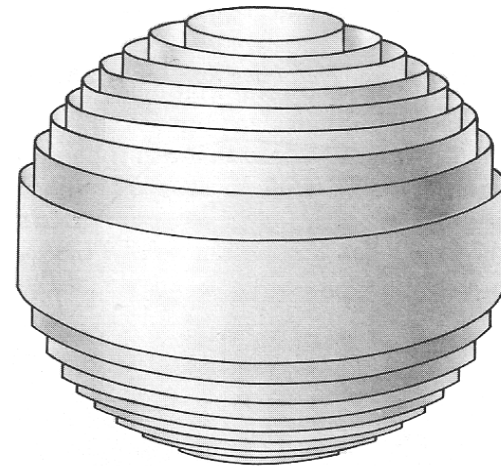

From the period of the oscillations, you can determine the cross sectional area S .

Experimental determination of the Fermi surface

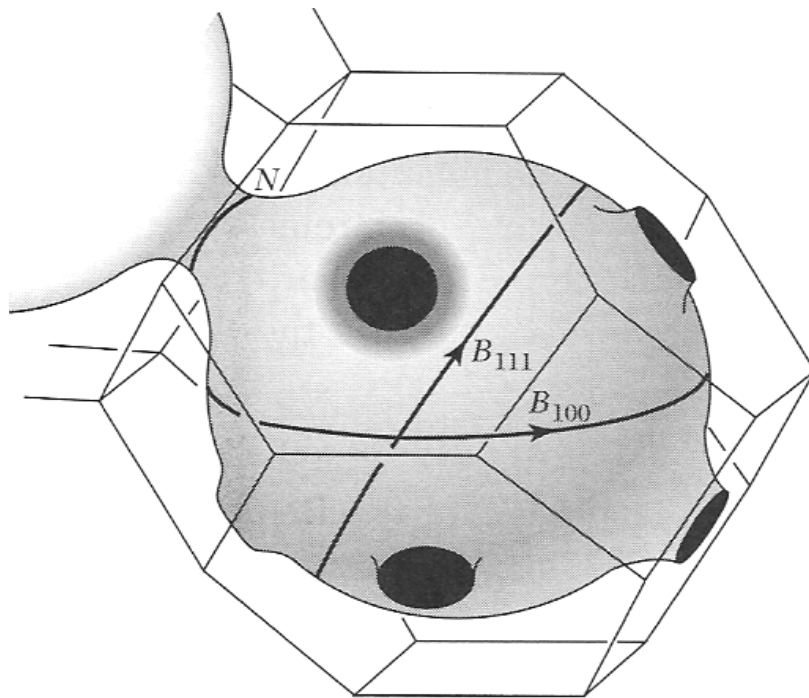

Kittel

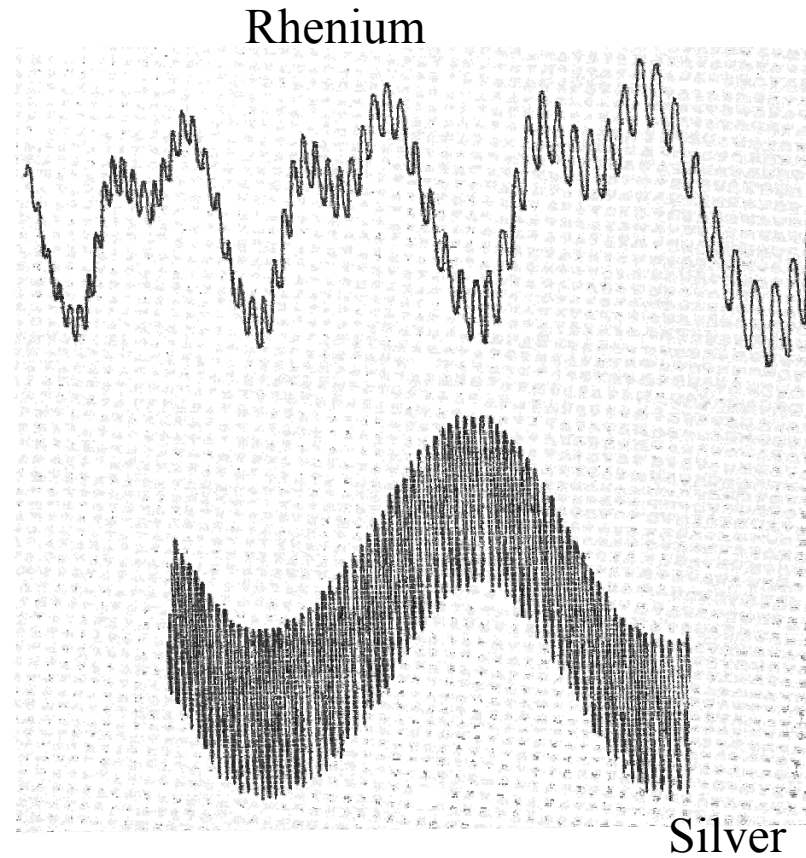

de Haas - van Alphen

De Haas - van Alphen effect

The magnetic moment of gold oscillates periodically with $1/B$

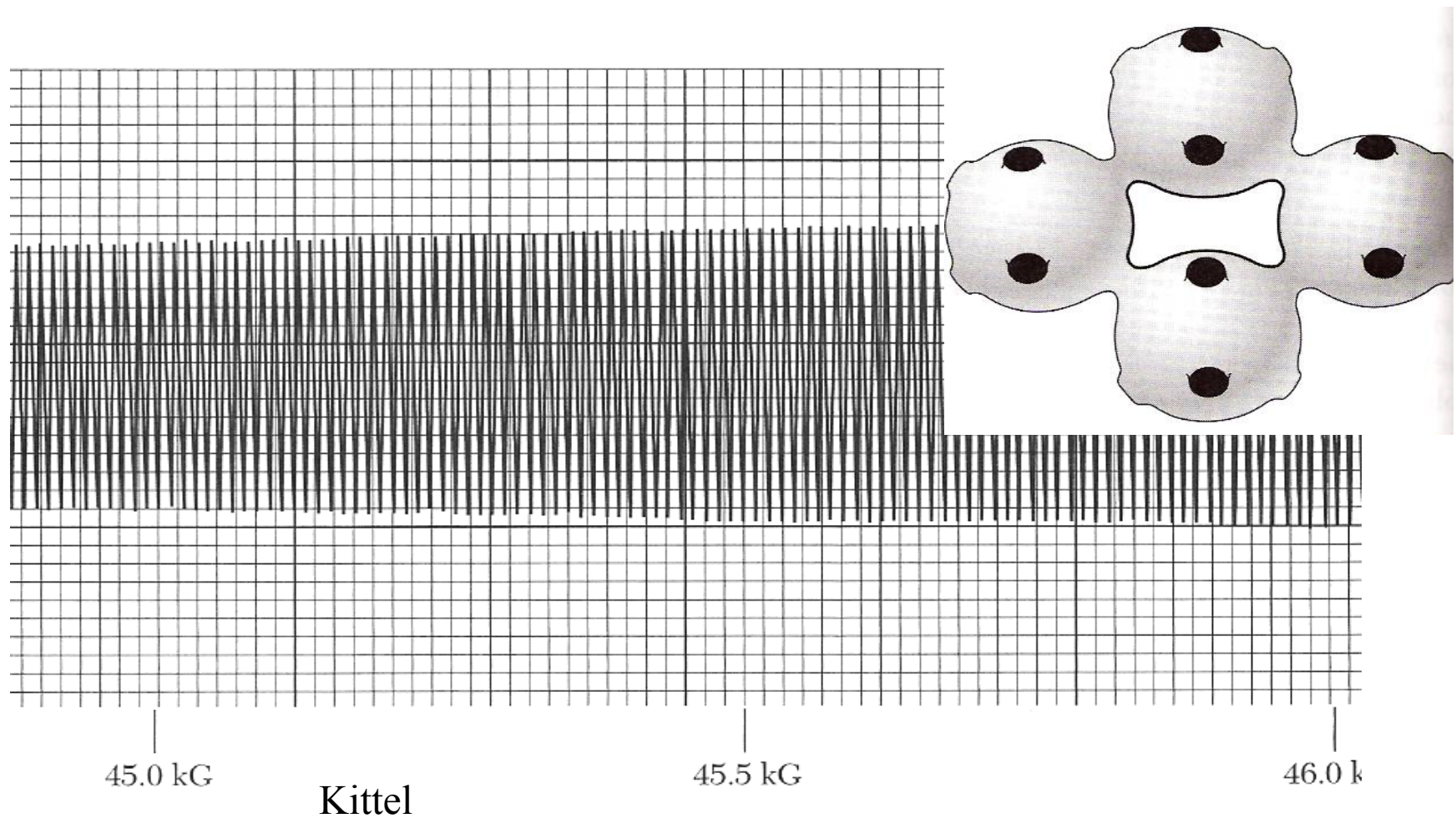

1A 2A 3B 4B 5B 6B 7B 8 1B 2B 3A 4A 5A 6A 7A NG

<http://www.phys.ufl.edu/fermisurface/>

H																	He	
Li	Be											B	C	N	O	F	Ne	
Na	Mg											Al	Si	P	S	Cl	Ar	
K	Ca	Sc	Ti	V	Cr	Mn	Fe	Cu	Ni	Cu	Zn	Ga	Ge	As	Se	Br	Kr	
Rb	Sr	Y	Zr	Nb	Mo	Tc	Ru	Rh	Pd	Ag	Cd	In	Sn	Sb	Te	I	Xe	
Cs	Ba	Lu	Hf	Ta	W	Re	Os	Ir	Pt	Au	Hg	Tl	Pb	Bi	Po	At	Rn	
Fr	Ra	Lr	Rf	Db	Sg	Bh	Hs	Mt	Uut	Uuq	Uub	Uut	Uuq	Uup	Uub	Uus	Uuo	
			<p>•</p> <p>••</p>															
			La	Ce	Pr	Nd	Pm	Sm	Eu	Gd	Tb	Dy	Ho	Er	Tm	Yb		
			Ac	Th	Pa	U	Np	Pu	Am	Cm	Bk	Cf	Es	Fm	Md	No		

magnets :

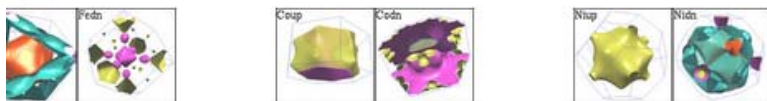

native Structures :



Magnetism

diamagnetism

paramagnetism

ferromagnetism (Fe, Ni, Co)

ferrimagnetism (Magnet Eisenstein)

antiferromagnetism

$$H = -\sum_i \frac{\hbar^2}{2m_e} \nabla_i^2 - \sum_A \frac{\hbar^2}{2m_A} \nabla_A^2 - \sum_{i,A} \frac{Z_A e^2}{4\pi\epsilon_0 r_{iA}} + \sum_{i<j} \frac{e^2}{4\pi\epsilon_0 r_{ij}} + \sum_{A<B} \frac{Z_A Z_B e^2}{4\pi\epsilon_0 r_{AB}}$$

Coulomb interactions cause ferromagnetism not magnetic interactions.

Magnetism

$$\vec{B} = \mu_0 (\vec{H} + \vec{M})$$

magnetic induction field \vec{B} magnetic intensity \vec{H} magnetization \vec{M}

$$\vec{M} = \chi \vec{H}$$

χ is the magnetic susceptibility

$\chi < 0$ diamagnetic

$\chi > 0$ paramagnetic

χ is typically small (10^{-5}) so $B \approx \mu_0 H$